

# Teaching Station Junior

A/V control platform for medium-sized classrooms



preparing your laptop for the TSJr

[Classroom Lectern / Podiums Home](#)

[University of Toronto Home](#)



Home

What

How

Connections

Where

When

Handbook

Troubleshooter

Contact

Design

Installation

Committee

PLAN – TYPICAL INSTALLATION 'FLOATING' FROM WALL

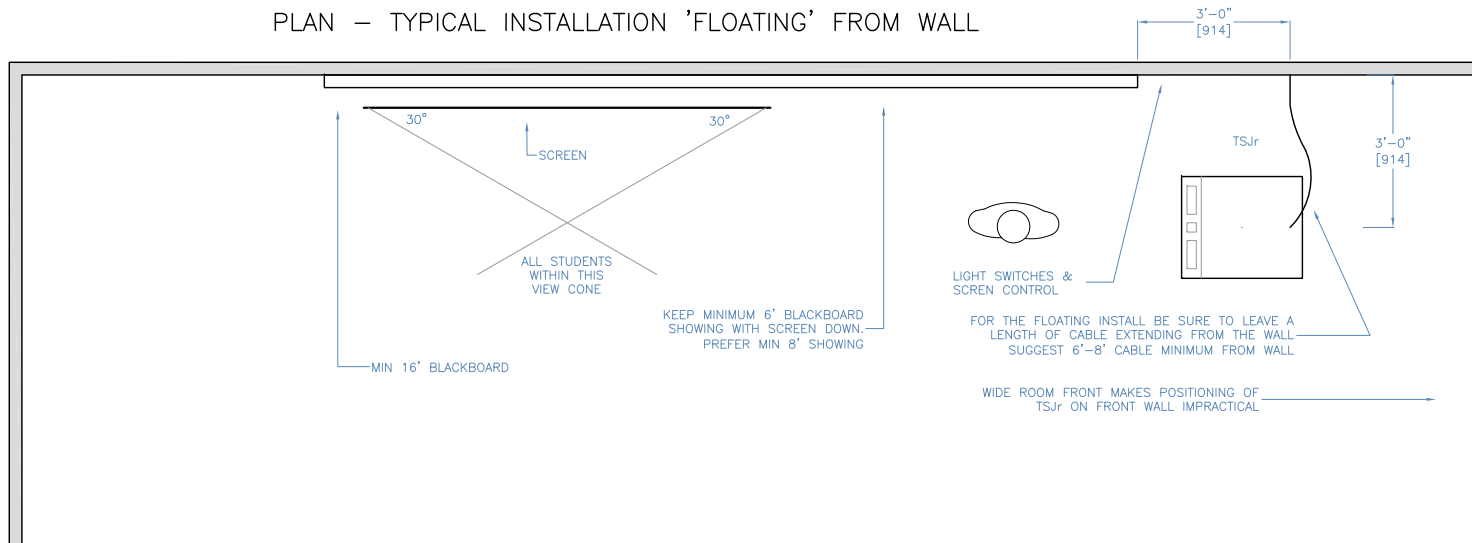

ROOM FRONT – TYPICAL INSTALLATION 'FLOATING' AWAY FROM WALL

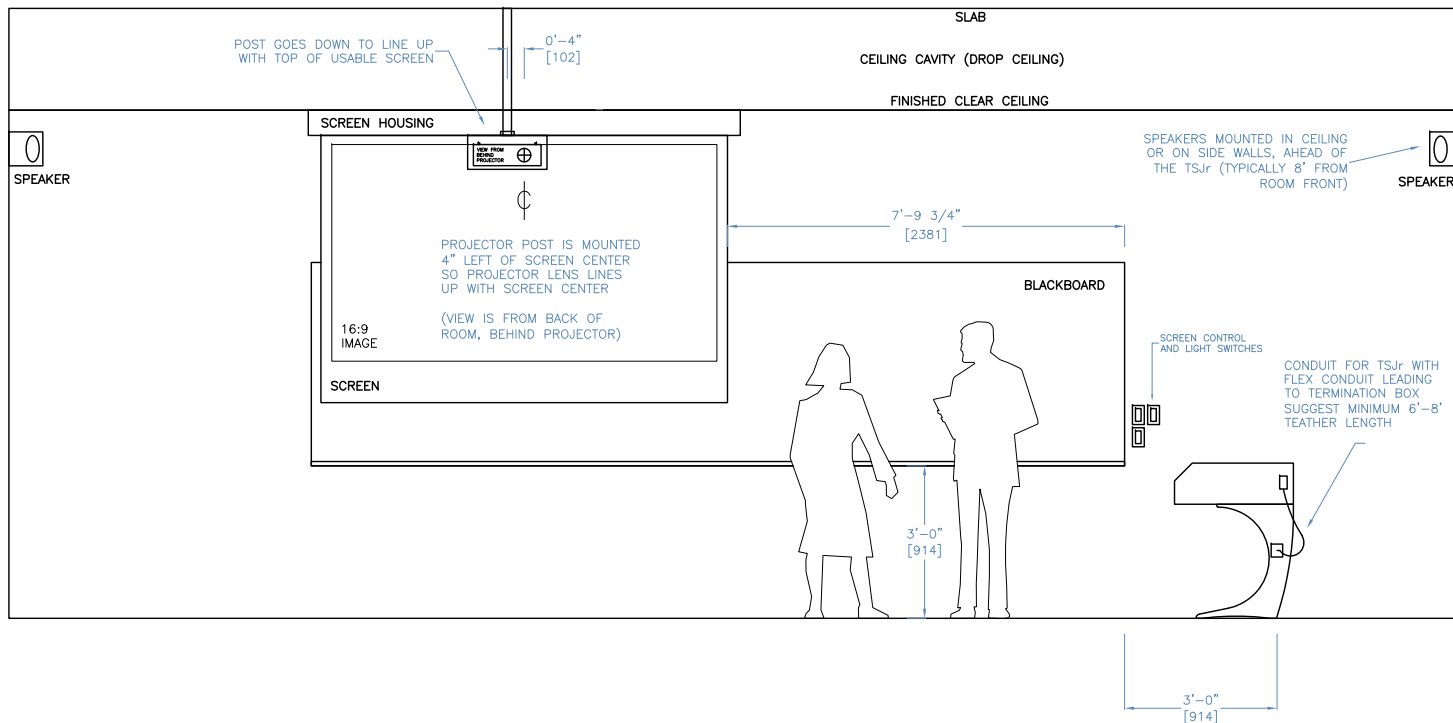

P-3

FLOATING  
INSTALLATION

PROJECT

TEACHING STATION JR  
UoT AV CONTROL BASE FOR  
MEDIUM SIZE CLASSROOMS

DATE

UPDATED JAN 2013

DRAWING

BURL CRONE (UoT)  
burl.crone@utoronto.ca

NOTE

BUILDER MAY MAKE INCREMENTAL  
CHANGES FOR CONSTRUCTION  
PURPOSES AS LONG AS  
FUNCTION IS RETAINED



UNIVERSITY of TORONTO  
Office of Space Management  
www.osm.utoronto.ca

SIDE VIEW  
TYPICAL INSTALLATION ON SIDE WALL WITH SCREEN COVE

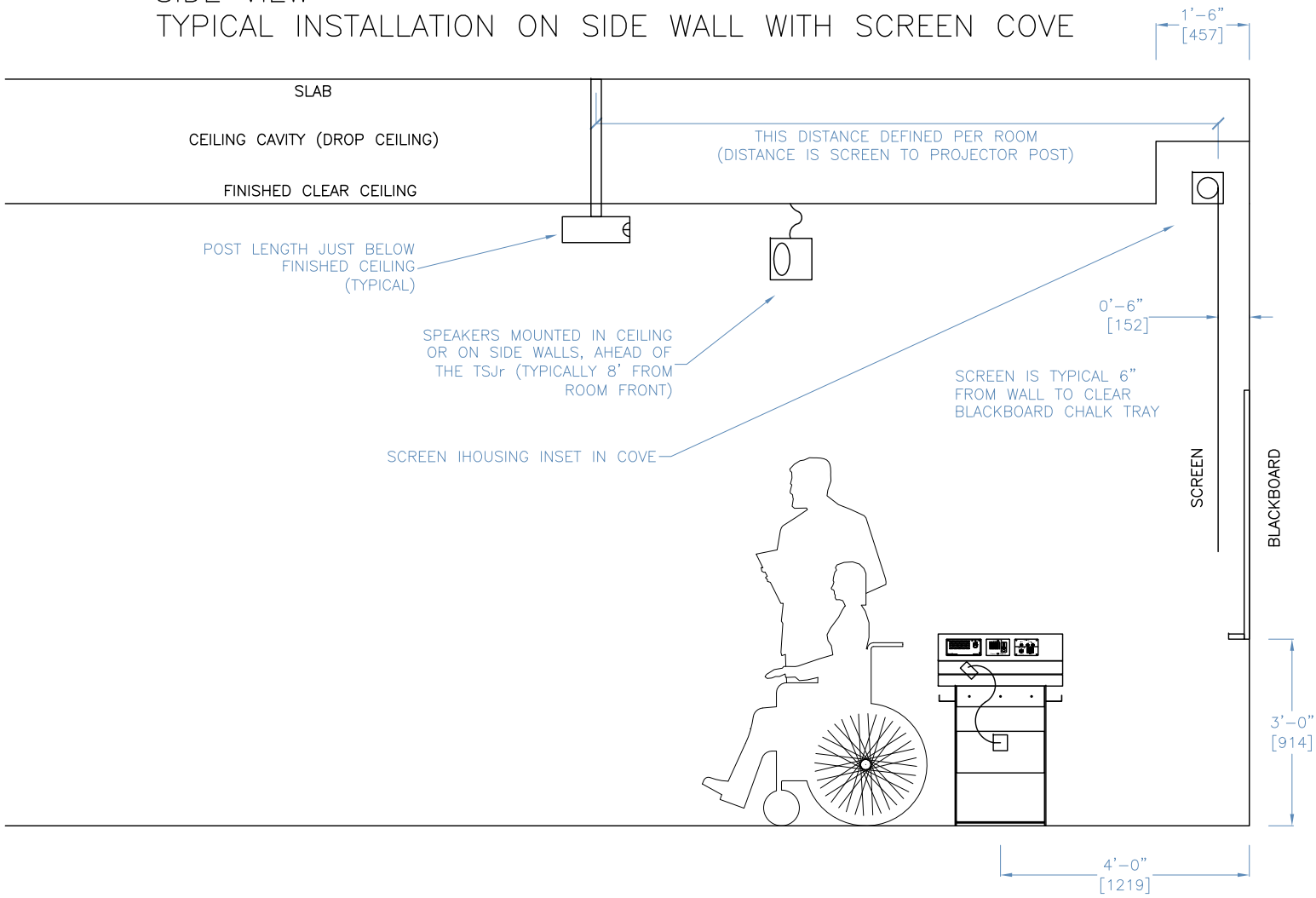

P-4  
SECTION WITH  
SCREEN COVE

PROJECT  
TEACHING STATION JR  
UoT AV CONTROL BASE FOR  
MEDIUM SIZE CLASSROOMS

DATE  
UPDATED JAN 2013

DRAWING  
BURL CRONE (UoT)  
burl.crone@utoronto.ca

NOTE  
BUILDER MAY MAKE INCREMENTAL  
CHANGES FOR CONSTRUCTION  
PURPOSES AS LONG AS  
FUNCTION IS RETAINED

TOP VIEW  
GREY IS FRAME UNDERNEATH

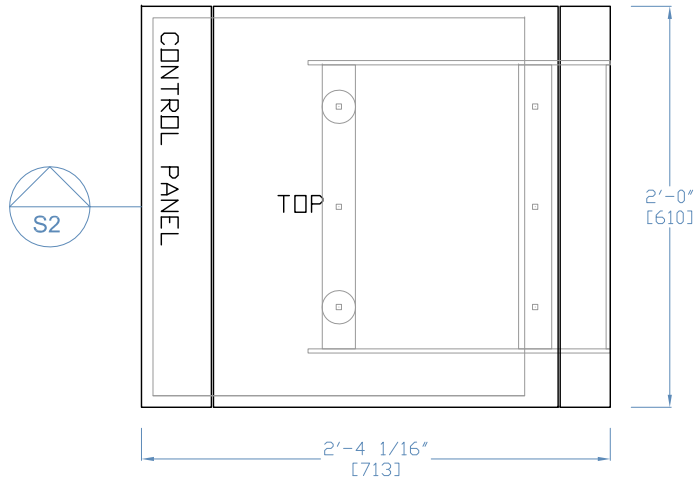

SECTION VIEW FROM TOP  
SHOWING BOX CUT-THROUGH AND  
INTERIOR MOUNTING BLOCK

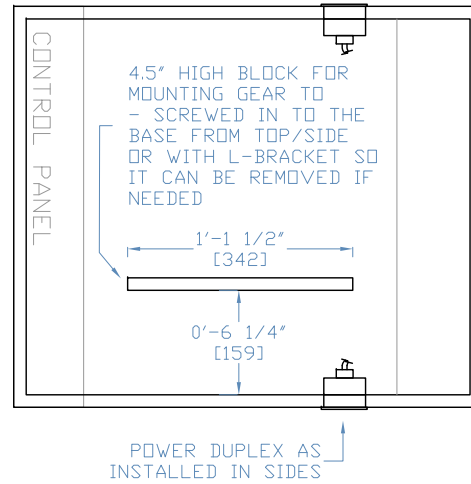

FRONT VIEW

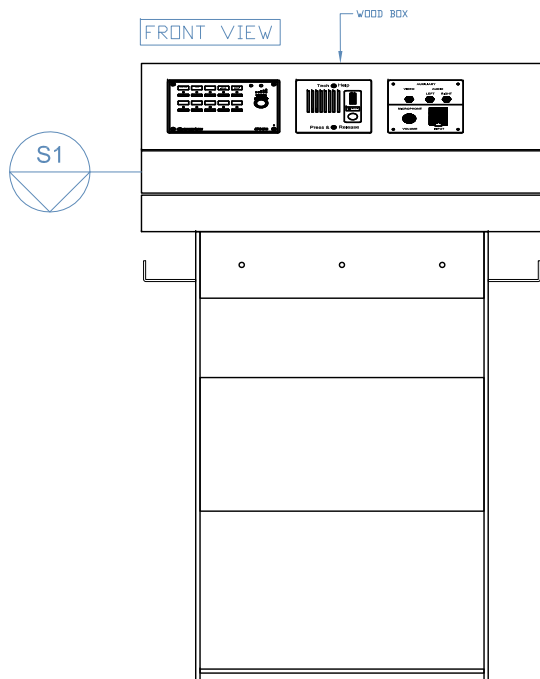

GAP 1/8 to 1/4" FOR VENTILLATION

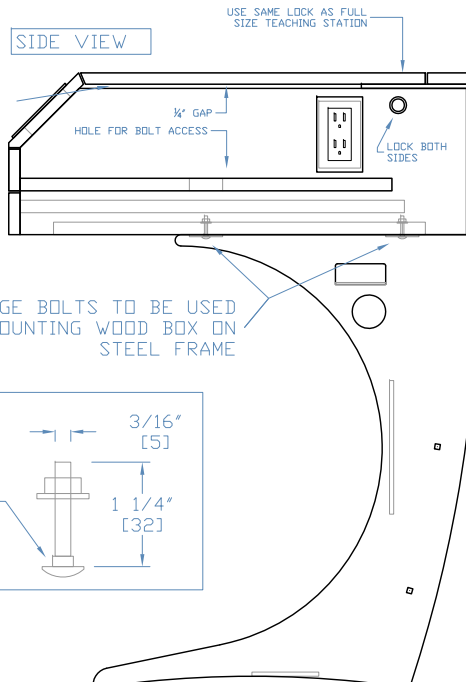

DETAIL

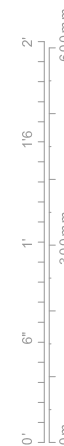
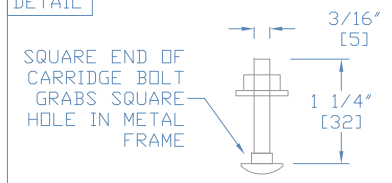

A-3  
SECTION

PROJECT

TEACHING STATION JR  
UoT AV CONTROL BASE FOR  
MEDIUM SIZE CLASSROOMS

DATE

UPDATED JAN 2013

DRAWING

BURL CRONE (UoT)  
burl.crone@utoronto.ca

NOTE

BUILDER MAY MAKE INCREMENTAL  
CHANGES FOR CONSTRUCTION  
PURPOSES AS LONG AS  
FUNCTION IS RETAINED



# TSJr CONDUIT – TYPICAL

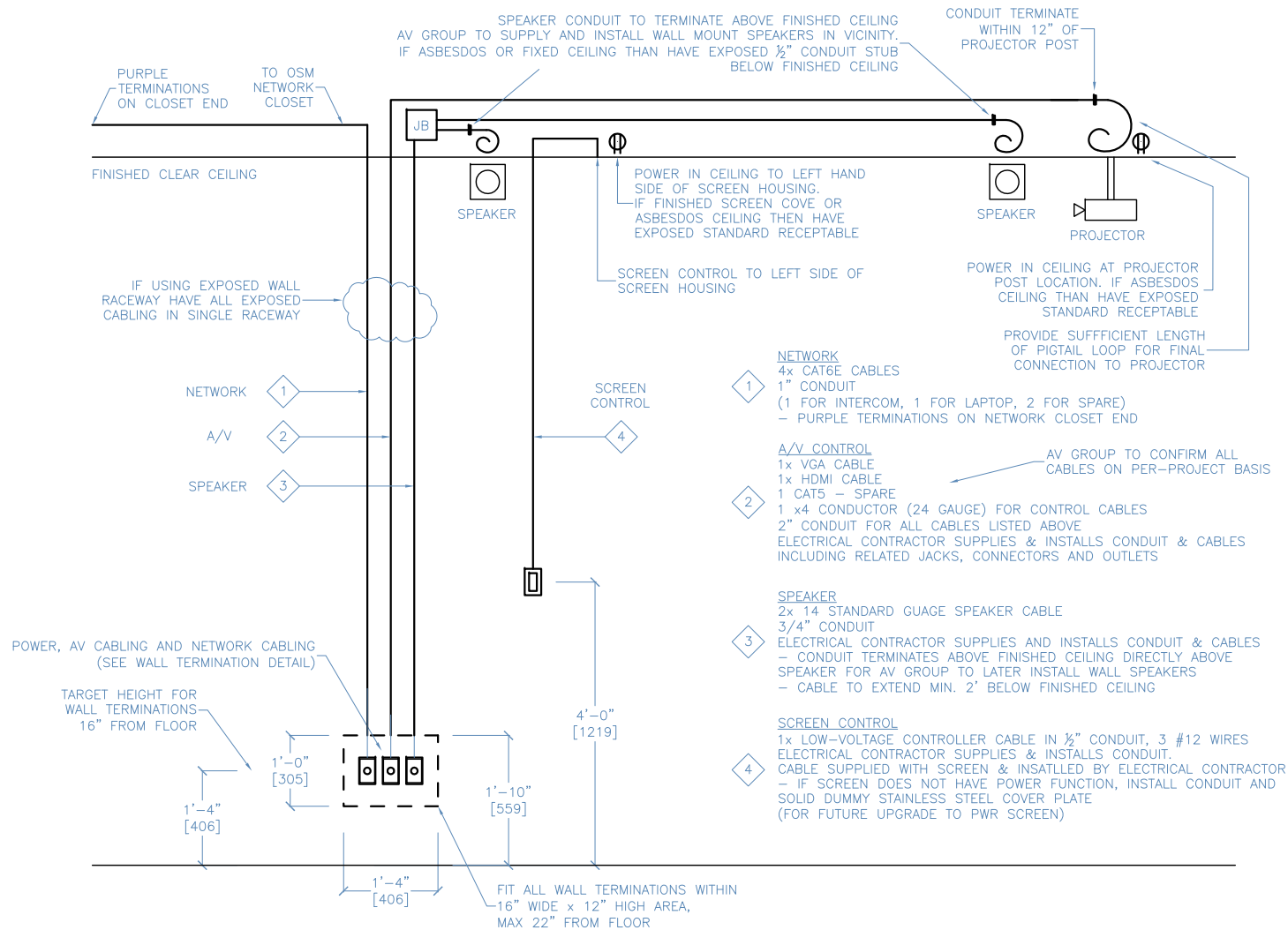

## E-1 CONDUIT PLAN

PROJECT  
 TEACHING STATION JR  
 UoT AV CONTROL BASE FOR  
 MEDIUM SIZE CLASSROOMS

DATE  
 UPDATED JAN 2013

DRAWING  
 BURL CRONE (UoT)  
 burl.crone@utoronto.ca

NOTE  
 BUILDER MAY MAKE INCREMENTAL  
 CHANGES FOR CONSTRUCTION  
 PURPOSES AS LONG AS  
 FUNCTION IS RETAINED

CLASSROOM TSJr CONDUIT DETAIL  
 burl.crone@utoronto.ca Mar 8 2012

